

Chic collection:

Chic, Chic Air, Chic Lounge,
Chic Tables



profim



"Both Chic and Chic Air try to propose a good answer to a heavy contract furniture in a domestic suit. Chic tends to be more sensual, elegant, classic, classy, as Chic Air fits a minimalistic approach with character and universality."

Christophe Pillet
Product Designer

Chic Air collection:



reddot design award
winner 2017



Minimalism. Lightness. Elegance.

Chic

Lightness, elegance and universal design – these are the distinctive features of the Chic collection. A delicate cross-section of the chair makes it look unusually light. The Chic family includes a chair with a thin, metal frame, either with 4-legged base or wooden legs, as well as a swivel armchair with memory swivel return feature or regular with glides.









Unusual spaces call for unique furniture. Our impressive chairs and armchairs from the Chic collection do not overwhelm the interior, yet their subtle profile and pure form are conspicuous.

Elegance and harmony

The Chic chairs are compact in form and universal in style, which is essential in less formal, but still elegant spaces, such as hotel rooms, cafés, restaurants, lounges or office lobbies. There are tables to go with the chairs: a well-matched set which makes any space look harmonious.





Functionality and quality

4-legged chairs are a perfect match for spaces where functionality and beauty are equally important, such as conference rooms and representative office spaces. Memory swivel return feature allows keeping chairs in order.







A moment to relax

The aesthetic and subtle form of Chic armchair invites you to unwind and is perfect for meetings in a casual atmosphere.

The armchairs are designed for relaxation zones. The profiled shape of shell and soft foam allow you to rest in full comfort.



Chic Air

The Chic Air furniture is extraordinarily elegant and distinguished by minimalistic, sophisticated form. The collection includes compact chairs and benches as well as matching distinctive armchairs. Every model is available with a thin, metal frame or on wooden legs.





reddot design award
winner 2017





Refined and carefully considered lines as well as original foam shape, hard to achieve, make the chair a real eye-catcher in the room. Chic Air was inspired by the need for seats matching modern and minimalistic spaces.



NEW YORK

LONDON

TOKYO







Geometry of shape

The collection is based on angular, geometric forms and on the delicate cross-section of the frame supporting the chair. The Chic Air armchairs are perfect for those who plan to furnish a lobby, office or lounge with unusually comfortable, distinctively designed chairs with top-notch seat finishing.



The perfect match

Original slim cross-sections of the Chic Air chairs are a result of an advanced process of joining two shells, while concealing their connecting elements. What makes the collection even more special is the possibility of joining two different kinds of upholstery – high quality leather on outer side and soft fabric inside.





Chic Lounge

It delights with its soft lines, lightness and carefully designed shape, which ensures comfort of use. It is available in two variants – on the wire frame and on 4-star base. The armchair is available in both high and low backrest versions. The collection is complemented by an elegant footrest and a soft cushion placed on a high backrest.





Stylish relaxation zone

The collection has been created with modern relaxation zones in mind, which are an important element of office and hotel space. The armchairs have exceptionally comfortable seats, which encourage rest and casual meetings. Ergonomic backrest allows to relax, and carefully thought-out accessories emphasise the informal character of the collection.





A well-deserved rest

The model on a thin 4-star base allows for a gentle floating, which relaxes and guarantees a moment of rest. The combination of impressive design and comfortable seat makes the armchair an ideal addition to an elegant interior. The chairs are extremely comfortable, encouraging informal meetings over a cup of coffee or a glass of wine.







Design and comfort

The collection is distinguished by minimalist, elegant design, while the style is dominated by subtle forms that blend perfectly with many different spaces. Each element is made with the greatest care, giving the possibility of combining leather with fabric. While the eye is attracted by the light form and thin cross-section, maximum comfort is still guaranteed.



Chic Tables

The collection includes a wide range of bases, shapes, heights and table-top sizes. Thanks to a large number of finishes available, tables may be customised. The tables will therefore match any space without disturbing its décor and integrity.



RR Tables



RR40



RR30



RR20



RR10

RH Tables



RH30



RH20

CR Tables



CR40



CR41

CS Tables



CS30



CS40



CS41



Stylish diversity

The Chic tables are a natural complement to the Chic and Chic Air furniture. Harmonious, elegant style and light form of tables and chairs create a holistic space arrangement. Four available table top finishes – ceramic, glass, wooden or metal – allow you to create the interior in any style.



Ceramics

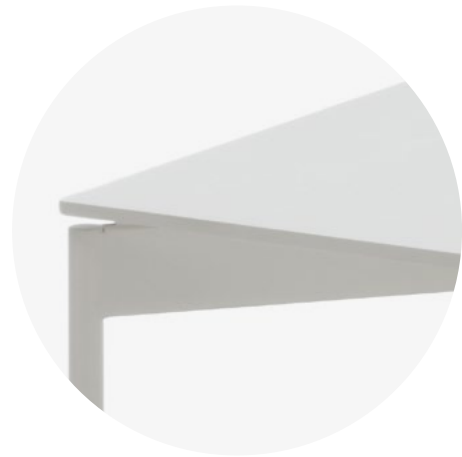

Metal



Tempered glass



Modified veneer

Configure your product

When ordering, please use code symbols.

Chic

Shell



Chair

20



Metal legs

H



Wooden legs

HW



Swivel, 4-star base

F



Armchair

10



Armchair

FU



Swivel armchair

FUS

Frame / Base

Frame / base colour ^{1, 2}



BLACK



METALLIC



EPO1

White



EPO2

Grey



EPO3

Graphite



CHROME



SATINE

Lacquer ³



H8



H6



H7



H12



H11



H5

Upholstery

Type & colour

SYMBOL

Additional

Glides

HARD

For soft floors.

FELT

For hard floors.

TEFLON

Universal.

Gaslift with memory,
without height adjustment

Standard:
applicable for 10FUS version.



Option: applicable for 20F version.



¹ Applicable for 20 version.

² F version available only in chrome.

³ Applicable for HW version.

Chic Air

Shell



Armchair

A

Backrest and armrests

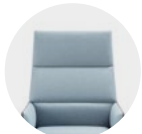

High backrest,
with armrests

10

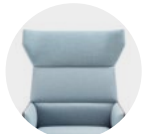

Wingback,
high backrest,
with armrests

11

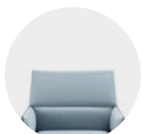

Low backrest,
with armrests

20

Frame



Metal legs

H



Wooden legs

HW

Frame colour



BLACK



METALLIC



EPO1

White



EPO2

Grey



EPO3

Graphite



CHROME



SATINE

Lacquer¹



H8



H6



H7



H12



H11



H5

Upholstery

Type & colour

SYMBOL

Option of mixing colours of the same fabric according to below scheme: A – inner part of the shell, B – outer part of the shell. In case of order of such option, following example should be specified: ST-5/ST-6 (where ST-5 – A, ST-6 – B).

It is possible to combine upholstery (Surface A) with Softline or leather (Surface B).

Additional

Glides

HARD

For soft floors.

FELT

For hard floors.

TEFLON

Universal.

¹ Applicable for HW version.

Shell

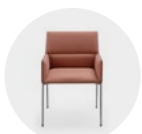

Chair

C

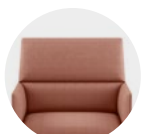

Low backrest,
with armrests

20

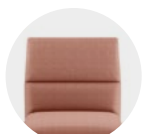

Low backrest,
without armrests

21



2-seat bench

B

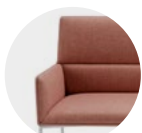

Low backrest,
with armrests

20

Configure your product

When ordering, please use code symbols.

Chic Lounge



Shell

Backrest ¹

Frame / Base

Frame / base colour

Upholstery



Chair

A



High backrest

10



Wire frame

V3



Footrest

P



Low backrest

20



4-star base ¹

F



BLACK



METALLIC



EPO1

White



EPO2

Grey



EPO3

Graphite



CHROME



SATINE ²

Type & colour

SYMBOL

Option of mixing colours of the same fabric according to below scheme: A – inner part of the shell, B – outer part of the shell. In case of order of such option, following example should be specified: ST-5/ST-6 (where ST-5 – A, ST-6 – B).

It is possible to combine upholstery (Surface A) with Softline or Leather Premium (Surface B).

Additional

Cushion for the high backrest



CU

Glides

HARD

For soft floors.

FELT

For hard floors.

TEFLON

Universal.

¹ Applicable for A version.

² Not applicable for F version.

Chic Tables ¹

Frame / Base



Round

RR

Height



Ø 800 mm,
h=480 mm

40



Ø 800 mm,
h=660 mm

30



Ø 800 mm,
h=740 mm

20



Ø 800 mm,
h=1100 mm

10



Legs

RH



Ø 800 mm,
h=660 mm

30



Ø 800 mm,
h=740 mm

20

Frame colour ²



BLACK



METALLIC



EPO1

White



EPO2

Grey



EPO3

Graphite



CHROME



SATINE

Table top

Tempered glass



G1

Milky



G2

Black



G3

Taupe
(RAL 7044)



G4

Grey (RAL 7042)

Ceramics



CER1

White



CER2

Grey



CER3

Graphite

Metal



EPO1

White



EPO2

Grey



EPO3

Graphite

Modified veneer



HM10

Bleached oak

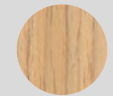

HM11

Classic oak

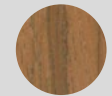

HM12

Cardinal oak

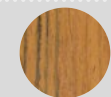

HM30

Teak



HM20

Wenge classic

Additional

Glides

HARD

For soft floors.

FELT

For hard floors.

TEFLON

Universal.

¹ Chic RH / RR tables with metal and ceramic table top (applies only if frame and top are made of EPO1, EPO2, EPO3, with hard or teflon glides) are suitable for outdoor use according to EN 12944-2 cat. C3.

² Frame colour in Chic Restaurant Tables RR applies to column only. Cast iron base always black.

Configure your product

When ordering, please use code symbols.

Chic Tables





Table

Dimension







Frame colour

Table top



		
Square	1200 x 1200 x 250 mm	800 x 800 x 250 mm
CS	41	40





450 x 450 x 560 mm
30



		
Round	Ø 1200 mm, h=250 mm	Ø 800 mm, h=250 mm
CR	41	40

	
BLACK	METALLIC
	
EPO1 White	EPO2 Grey
	
EPO3 Graphite	CHROME
	
SATINE	

Tempered glass		
		
G1 Milky	G2 Black	G3 Taupe (RAL 7044)
		
G4 Grey (RAL 7042)		

Ceramics		
		
CER1 White	CER2 Grey	CER3 Graphite

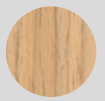
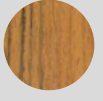
Metal ¹		
		
EPO1 White	EPO2 Grey	EPO3 Graphite

Modified veneer		
		
HM10 Bleached oak	HM11 Classic oak	HM12 Cardinal oak
		
HM30 Teak	HM20 Wenge classic	

Additional

Glides	
HARD	For soft floors.
FELT	For hard floors.
TEFLON	Universal.

¹ Applicable for CS30 version.

Measurements

The measurements are approximate and can differ depending on the product configuration.
 Measuring methodology is available at this link: www.profim.eu/Measuring_methodology.pdf

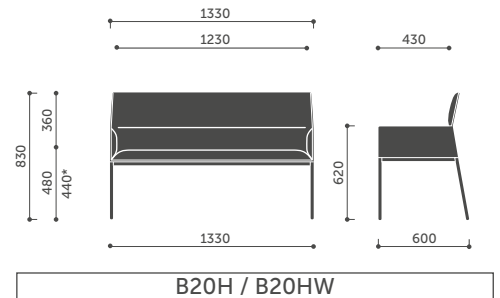
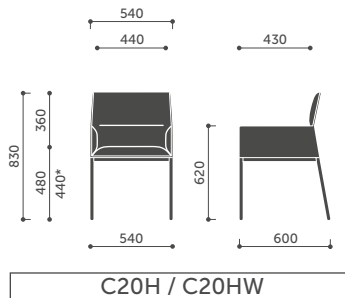
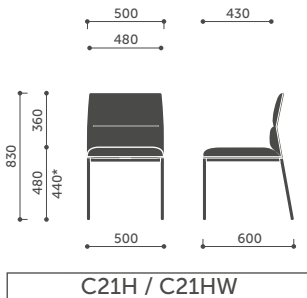
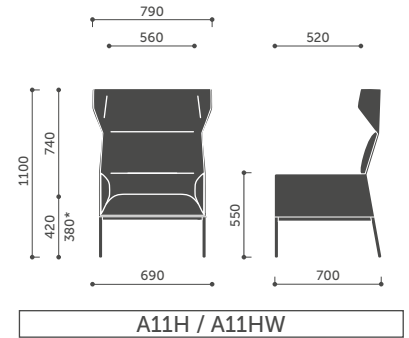
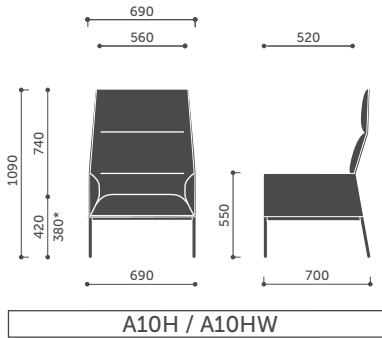
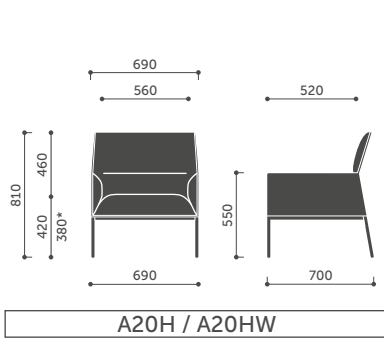
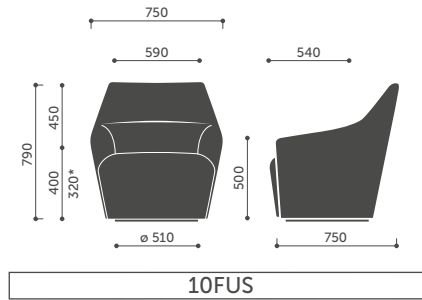
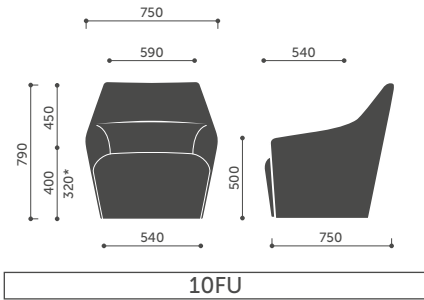
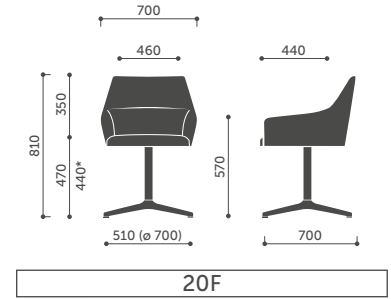
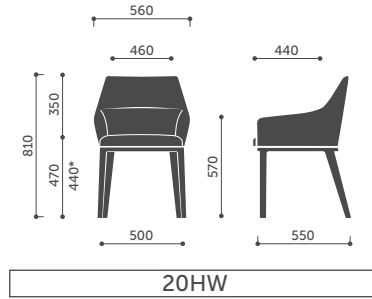
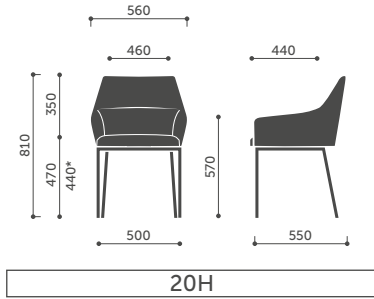

* Seat height is measured according to PN EN 16139 norm (with seat burden).

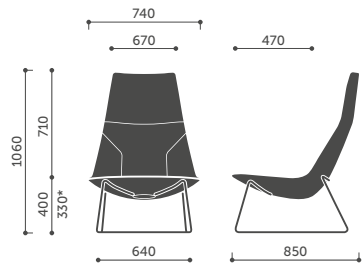

A10V3

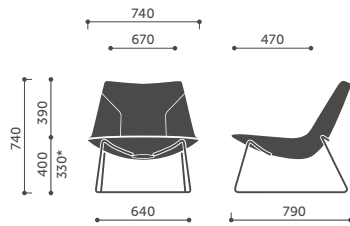

A20V3

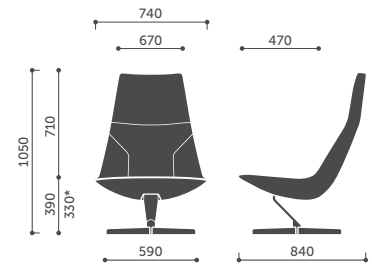

A10F

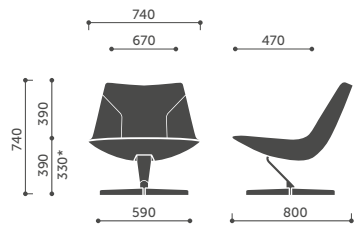

A20F

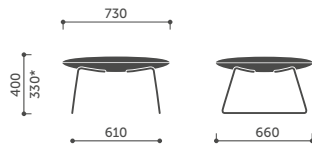

PV3

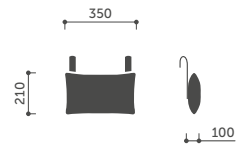

CU

* Seat height is measured according to PN EN 16139 norm (with seat burden).

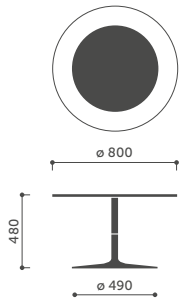

RR40

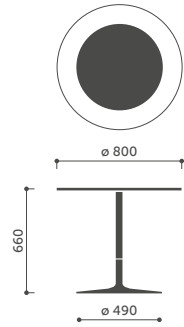

RR30

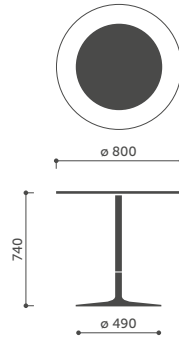

RR20

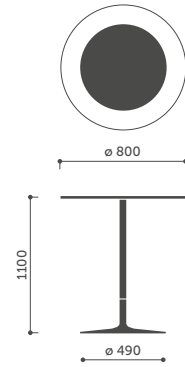

RR10

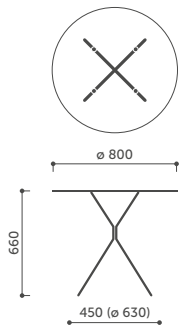

RH30

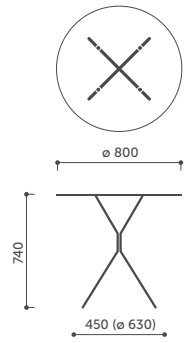

RH20

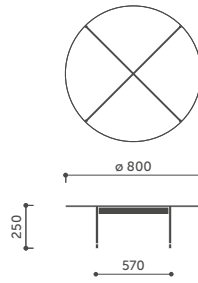

CR40

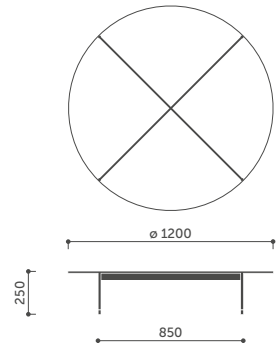

CR41

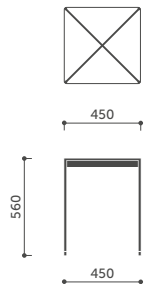

CS30

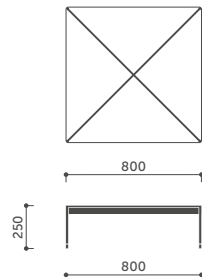

CS40

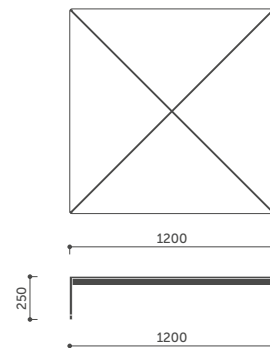

CS41



Profim and the Environment

In our operation we follow the sustainability principle. We operate in a responsible manner for the benefit of our customers, employees, suppliers, and the local community, but we always respect the environment.

In order to achieve our goals, we have implemented Environmental Management System based on the ISO 14001 standard, which allows for a comprehensive approach to ecology. We take into consideration and evaluate the way Chic products affect the environment during their entire life cycle.

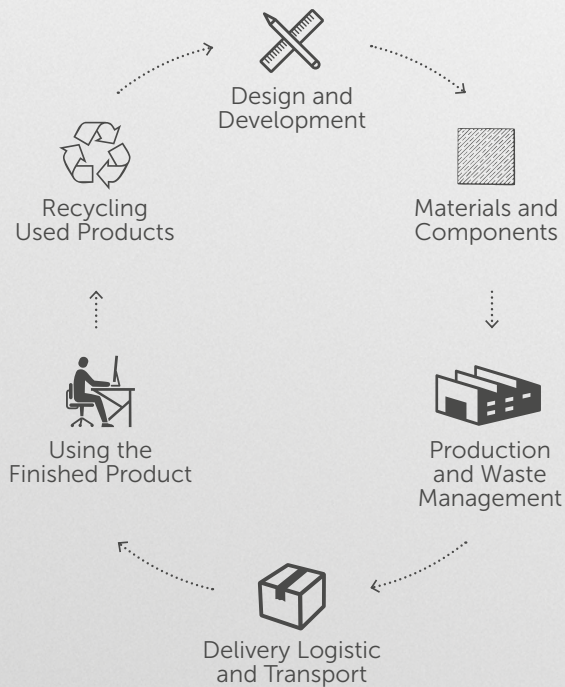

Chic

Product Environmental Information

(for Chic Air C20H)

Materials used:

Metals	kg	%
Steel	3.18	26.4
Plastics	kg	%
Plastics	0.14	1.1
Others	kg	%
Upholstery	0.92	7.6
Wood	5.96	49.5
PU Foam	1.84	15.4
Weight	12.04	100.0

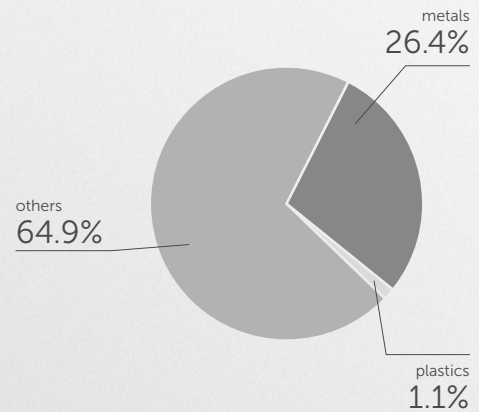

This product contains no chemical compounds harmful to human health or the environment (including PVC, chromium (VI), mercury or lead).

www.profim.eu

The producer reserves the right to conduct construction changes and improvements of the products.
Colours presented in the catalogue may vary from the original colours of furniture.



CHROMIUM (III)
Eco-Friendly Technology

CHROM (III)
Umweltfreundliche
Technologie

